

Lighting control using Triggers and Actions

Important

For Triggers and Actions to function correctly, the Net2 server must be running at all times.

Installing the hardware



The relay output of the I/O board is wired in series with the light switch allowing the I/O board to override the switch and turn the lights off.



Net2 Triggers and Actions can control the I/O board based on other Net2 actions. In this case we will use Setting/Unsetting the Intruder alarm as the trigger but any event (e.g. a Managers card presented to a specific reader) could also be used.

The I/O board needs to be configured before triggers and actions are set up. To see instructions for setting up the I/O board refer to: AN1066 - Installing an I/O board. < <http://paxton.info/506> >

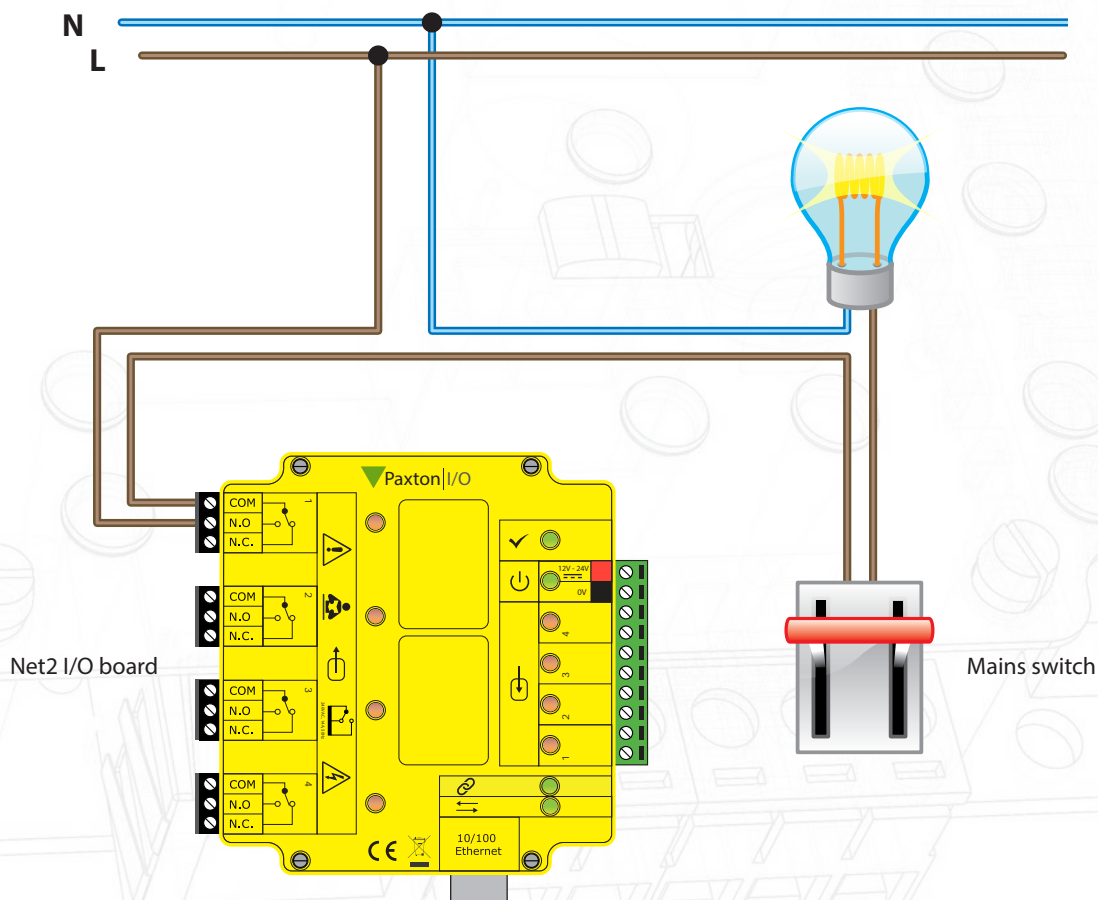

The Triggers and Actions feature is based around user defined rules. When an event occurs (Trigger) that is defined in a rule, a specific action is performed.

Setting up rules for Triggers and Actions

In the following screens we will create rules to turn the building lights On and Off depending on the setting of the intruder alarm.

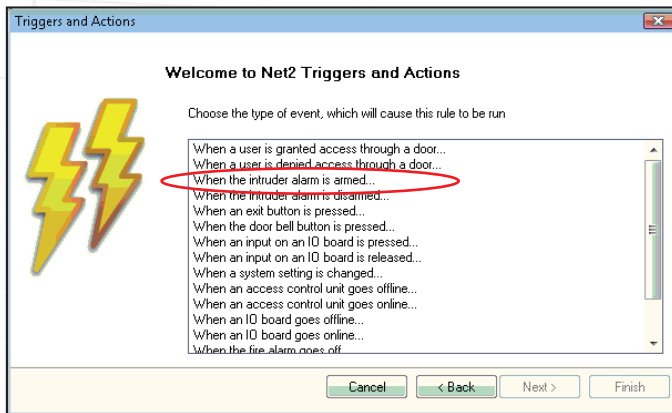

Turn building lights Off

Select Triggers and Actions from tree view. Click 'Add' - The title page displays - Click 'Next'!

Select 'When the intruder alarm is armed'!

Click 'Next'!

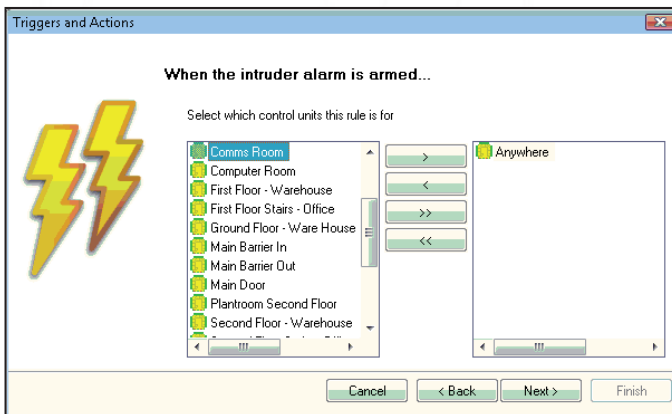

Select which ACU has intruder alarm integration. This can be set to 'Anywhere', or select the specific ACU's in that area.

Click 'Next'!

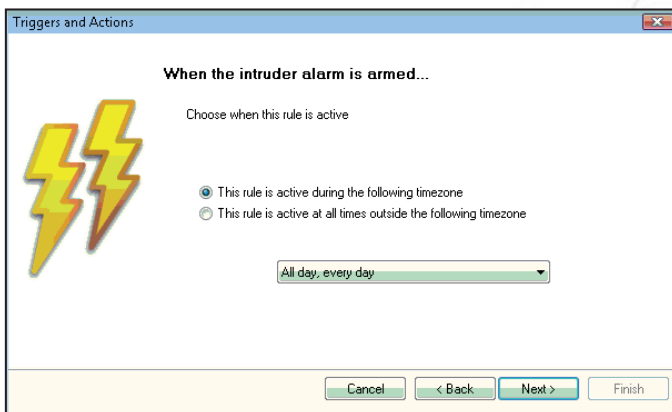

Select the relevant timezone from the menu.

Our example shows 'All day, everyday' as the selected timezone.

Click 'Next'!

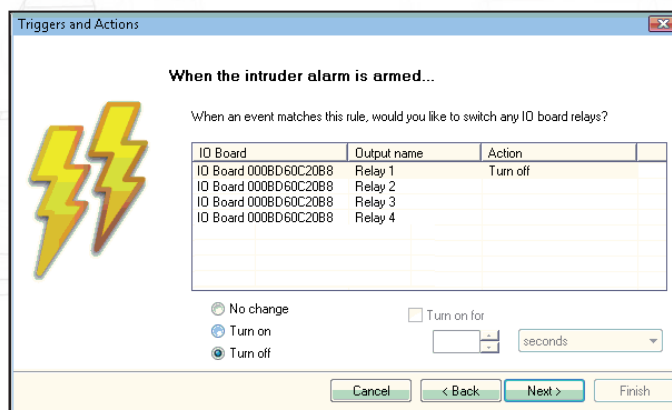

Select the relay on the I/O board linked to the lighting circuit.

Select 'Turn off'!

Click 'Next'!

The next three screens (not shown) give options for Email, SMS and Sounds to play on your PC when the event occurs. Click 'Next' to skip through these screens as required.

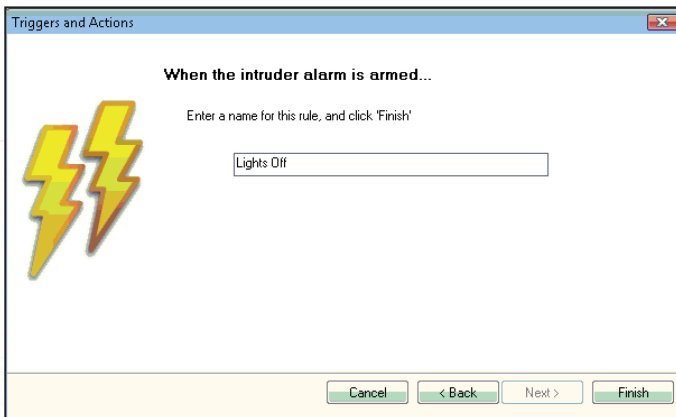

- Give the rule a descriptive name and click 'Finish' to save.

To restore the power to the building light circuit (allow control by local light switches during the day) another rule needs to be set up.

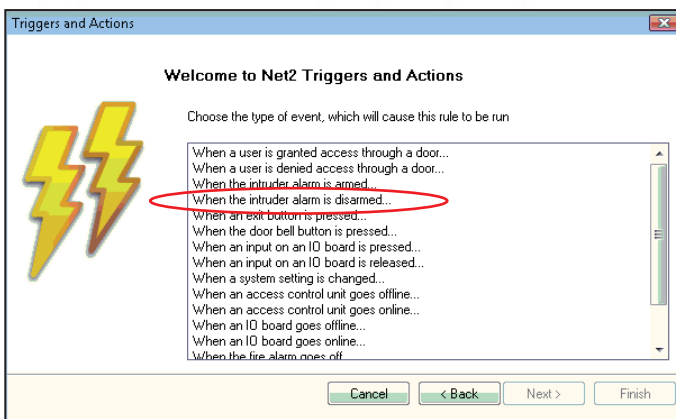

Turn building lights On

- Select Triggers and Actions from tree view. Click 'Add' - The title page displays - Click 'Next'.
- Select 'When the intruder alarm is disarmed'.
- Click 'Next'.

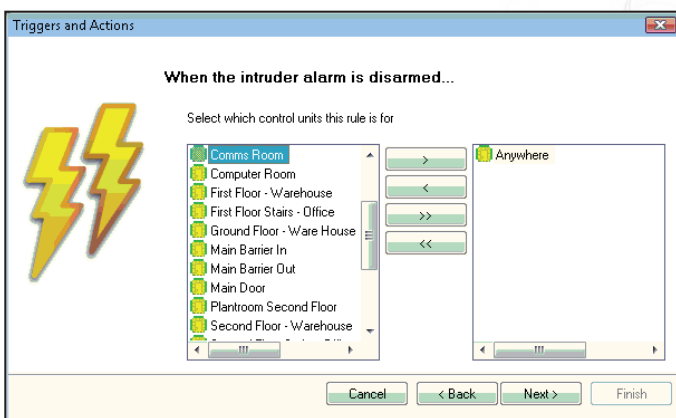

- Select which ACU has intruder alarm integration. This can be set to 'Anywhere', or select the specific ACU's in that area.
- Click 'Next'.

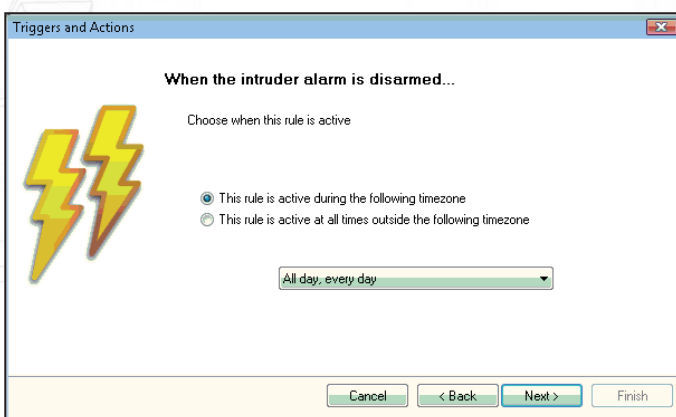

- Select the relevant timezone from the menu.
- Our example shows 'All day, everyday' as the selected timezone.
- Click 'Next'.

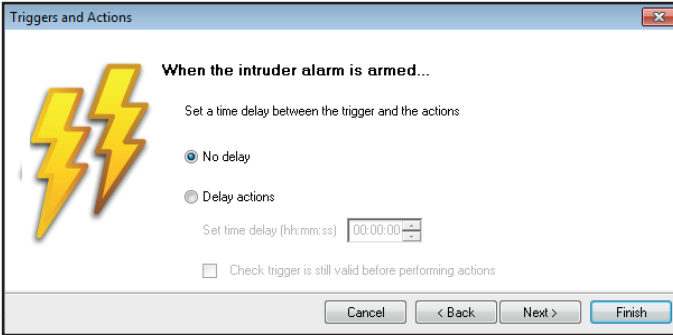

Select 'No delay'

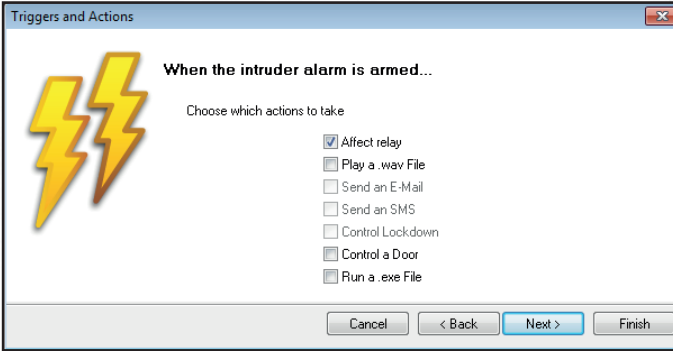

Select 'Affect relay'

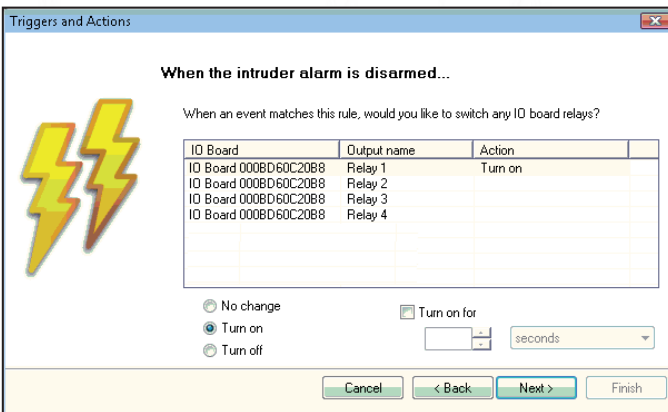

Select the relay on the I/O board linked to the lighting circuit.

Select 'Turn on!'.

Click 'Next!'.

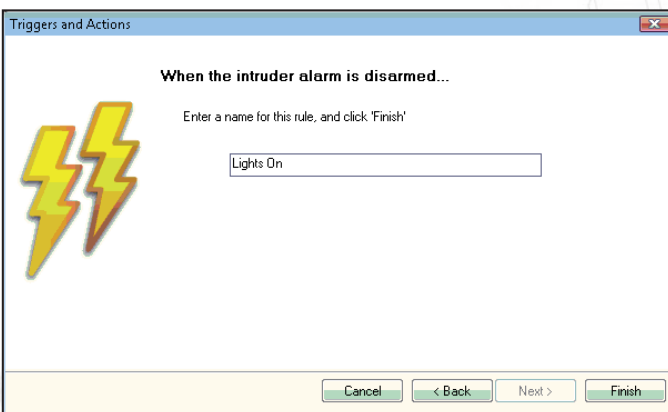

Give the rule a descriptive name and click 'Finish' to save.

We have now produced two rules that will control the Building lighting depending on the setting or unsetting of the Intruder Alarm.

Setting the Intruder alarm = Building Lights OFF

Unsetting the Intruder alarm = Building Lights ON